

landscape // hardscape // tree care // marine

2016-2017



Dimex LLC

**Consumer** product catalog

# 01

EDGING SYSTEMS

# Landscape edging

Our landscape edging products are known and requested by name by trade professionals because of their quality, durability and value. But you don't have to be a professional to use our easy-to-install landscape edging. Whether it's a bold, traditional edge or a sleek, modern line that you want, our edging products can give your planting beds, sidewalks and patios a professional look.

## NO-DIG LANDSCAPE EDGING

EASY TO INSTALL WITH NO DIGGING REQUIRED

► Compact retail footprint helps to maximize retail dollars per foot.



SMOOTH TOP DESIGN

### ORIGINAL NO-DIG EDGING

No-dig landscape edging capitalizes on a fast-growing DIY landscaping trend toward clean-looking bed lines that are quick and easy to install. The 1.5" tall, L-shaped profile sits on the ground surface, eliminating the need to dig or trench for installation. This profile design offers superior flexibility and workability versus competitive no-dig products.

Project kits include edging, anchoring spikes and connector(s).

Coils are available in a variety of lengths from 12' up to 100'.

Spike accessory packs are also available for separate purchase.

Compact coiled form permits long lengths to be merchandised, handled and shipped efficiently.

Manufactured in the USA from recycled polyethylene materials.

#### Product Features

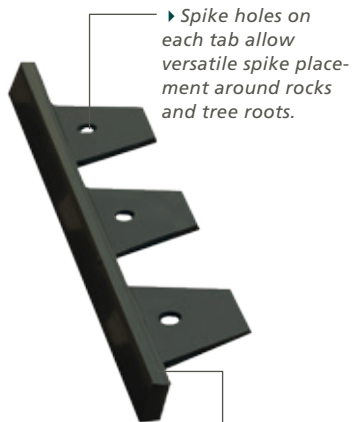

► Spike holes on each tab allow versatile spike placement around rocks and tree roots.

► L-shaped design allows edging to sit on the ground surface.

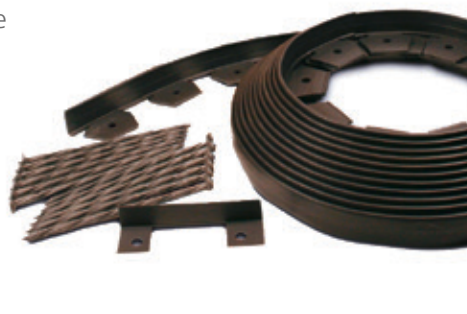

► Heavy Duty commercial grade option available.



**NEW**



**NO-DIG LAND DESIGN SERIES**

The scallop top design provides a decorative finished look that installs quickly and easily, with no digging required. At 2.5" in height, this edging system is ideal for landscaping with heavy ground cover including lava rock, stone and mulch.

Project kits include edging, connector, and 6 heavy duty anchoring stakes.

Boxed coils are available in 2.5" x 20' lengths.

Compact coiled form permits long lengths to be merchandised, handled and shipped efficiently.

Manufactured in the USA from recycled polyethylene materials.



▶ Anchoring spikes can be hammered through holes in the tabs to secure edging in place. Spike packs are available separately if additional anchoring is desired.



▶ Scallop top design option available in 20' coil. Comes with 1 connector and 6 anchoring stakes

**Product Features**

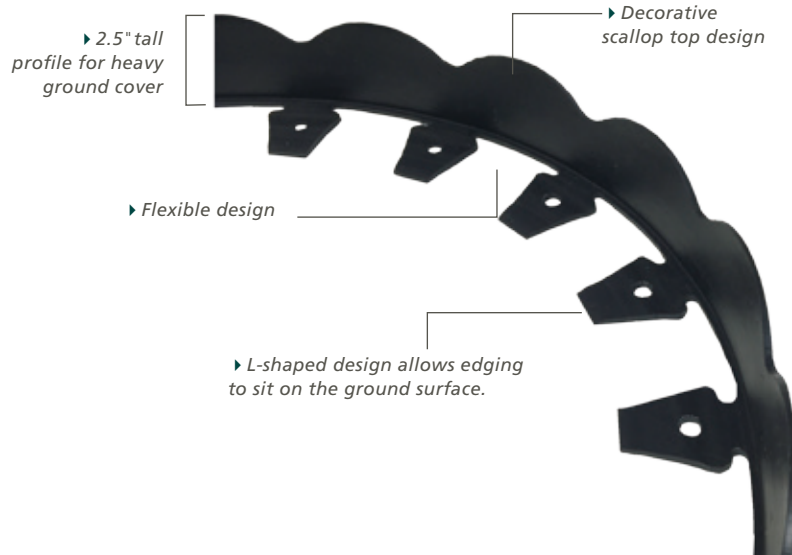

# Landscape edging

## DIG-IN LANDSCAPE EDGING

DESIGNED TO PROVIDE CLEAN PROFILES FOR HEAVY GROUND COVER AREAS



SMOOTH TOP DESIGN



NEW

SCALLOP TOP DESIGN

### ORIGINAL DIG-IN EDGING

Dig-in landscape edging strikes the perfect balance of flexibility and durability. The sleek, thin profile provides clean, crisp lines to any landscape bed. At 4.5" in height, this edging system provides increased ground defense against aggressive grasses growing under the edging and stands well up to string trimmers.

Project kits include edging and 6 heavy duty anchoring stakes.

Boxed coils are available in 4.5" x 20' lengths.

Compact coiled form permits long lengths to be merchandised, handled and shipped efficiently.

Manufactured in the USA from recycled polyethylene materials.

#### Product Features



► Taller profile allows for variable height. Anchoring stakes easily secure edging. Suggested installation: Use a minimum of one stake every 4'.

### DIG-IN LAND DESIGN SERIES

The new scallop top design provides a decorative finished look alternative while providing the same flexibility and durability as our original dig-in edging. Ideal for landscaping with heavy ground cover including lava rock, stone and mulch.

Project kits include edging and 6 heavy duty anchoring stakes.

Boxed coils are available in 4.5" x 20' lengths.

Compact coiled form permits long lengths to be merchandised, handled and shipped efficiently.

Manufactured in the USA from recycled polyethylene materials.

#### Product Features



► Decorative scallop top design

► The decorative edge design beautifies your landscape while a taller profile allows for variable height.





## POUND-IN LANDSCAPE EDGING

DESIGNED TO POUND INTO THE GROUND WITH A RUBBER Mallet



SMOOTH TOP DESIGN



NEW

SCALLOP TOP DESIGN

### ORIGINAL POUND-IN EDGING

Pound-in landscape edging allows do-it-yourselfers to vary the height of their edging installation from just 0.5" up to 2.5" tall. The bottom "teeth" are tapered in thickness and alternate in size to provide easier penetration into the ground with minimal digging. The continuous coil design minimizes connection points versus shorter length competitive pound-in products.

Project kits include edging and 2 heavy duty anchoring stakes.

Boxed coils are available in 12' and 20' lengths.

Compact coiled form permits long lengths to be merchandised, handled and shipped efficiently.

Manufactured in the USA from recycled polyethylene materials.

#### Product Features

▶ Smooth top design

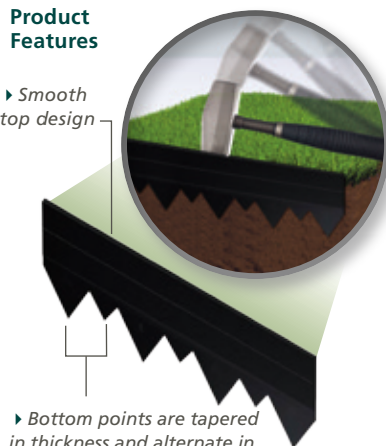

▶ Bottom points are tapered in thickness and alternate in size for easier installation.

### POUND-IN LAND DESIGN SERIES

The new scallop top design provides a decorative finished look with a variable wall height of up to 2.5". The decorative scallop top of the edging sits above ground, while the bottom "teeth" are tapered in thickness and alternate in size to provide easier penetration into the ground with minimal digging in a continuous coil format.

Project kits include edging and 2 heavy duty anchoring stakes.

Boxed coils are available in 20' lengths.

Compact coiled form permits long lengths to be merchandised, handled and shipped efficiently.

Manufactured in the USA from recycled polyethylene materials.

#### Product Features

▶ Decorative scallop top design

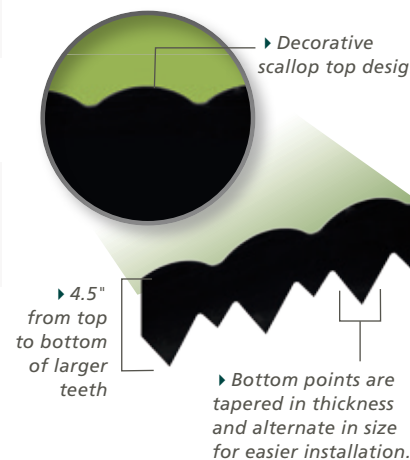

▶ 4.5" from top to bottom of larger teeth

▶ Bottom points are tapered in thickness and alternate in size for easier installation.



# Aluminium landscape edging

Durable lifetime performance with a high-end finished look for landscape beds.

## FOR MULTIPLE LANDSCAPE PROJECTS



Landscape beds



Gardens and tree rings



Walkways and pathways

## ALUMINUM LANDSCAPE EDGING

Unlike other metal edging products such as steel, aluminum is lighter, easier to work with, and does not rust or corrode. The overlapping connection design eliminates the need for a separate connector. Since aluminum materials are unaffected in hot climates, aluminum edging is a very popular choice in Southern and West Coast regions.

Project kits include edging and spikes.

Also available in 6' single lengths.

Spike accessory packs are also available for separate purchase.

Manufactured in the USA from recycled aluminum materials.

### Product Features

- ▶ Easy sliding installation
- ▶ Creates straight runs and curves with ease
- ▶ Permanent & low maintenance
- ▶ Rust and crack resistant
- ▶ Ends slide together for easy installation



▶ Before



▶ After



## Available in multiple finishes



▶ Black



▶ Bronze



▶ Brown



▶ Mill

## Sold in box kits or as individual pieces



▶ Each box kit contains four 6' pieces and twelve 10" steel spiral anchoring spikes

# Hardscape products

Keep pavers in place with versatile, proven edging systems for interlocking paver applications. Our hardscape products are engineered to provide heavy-duty support for paver walkways, patios, and even driveways. Manufactured from durable materials, our edging systems provide a distinct advantage over competing wood, concrete and steel systems.



## VINYL PAVER EDGING

Vinyl paver edging is made from commercial grade materials and can be used with a variety of commercial and residential applications including; sidewalks, patios and even driveways. The 1.75" tall L-shape profile can be installed with horizontal anchoring tabs adjacent to or underneath the pavers. Vinyl edging is heavier and stronger than competitive products made from polyethylene and is flexible enough to follow curves and designs. It can be cut with a regular hack saw.

Project kits include edging, spikes and connector (if applicable).

Also available in 6' single lengths with connector (if applicable).

Spike accessory packs are also available for separate purchase.

Manufactured in the USA from recycled vinyl materials.

### Product Features

► Ready to use for straight sections or clip spine where needed for curves.



NEW

UNLIKE OTHER METAL EDGING PRODUCTS, ALUMINUM IS LIGHTER, CURVES EASILY AND DOES NOT RUST OR CORRODE.

## ALUMINUM PAVER EDGING

Aluminum paver edging is a high end edge restraint and can be used for a variety of commercial and residential applications including; sidewalks, patios and even driveways. The 1.6" tall L-shape profile can be installed with horizontal anchoring tabs adjacent to or underneath the pavers. This aluminum profile is great for straight sections and is flexible enough to make curves and angles with ease. It can be cut with a regular hack saw.

Project kits include edging & spikes.

Also available in 6' single lengths.

Spike accessory packs are also available for separate purchase.

Manufactured in the USA from recycled aluminum materials.

► L-shape profile allows easy backfill with soil or rocks against edging.

► Horizontal tabs can be installed adjacent to or underneath pavers.

► Predrilled holes make anchoring spikes easy to install.

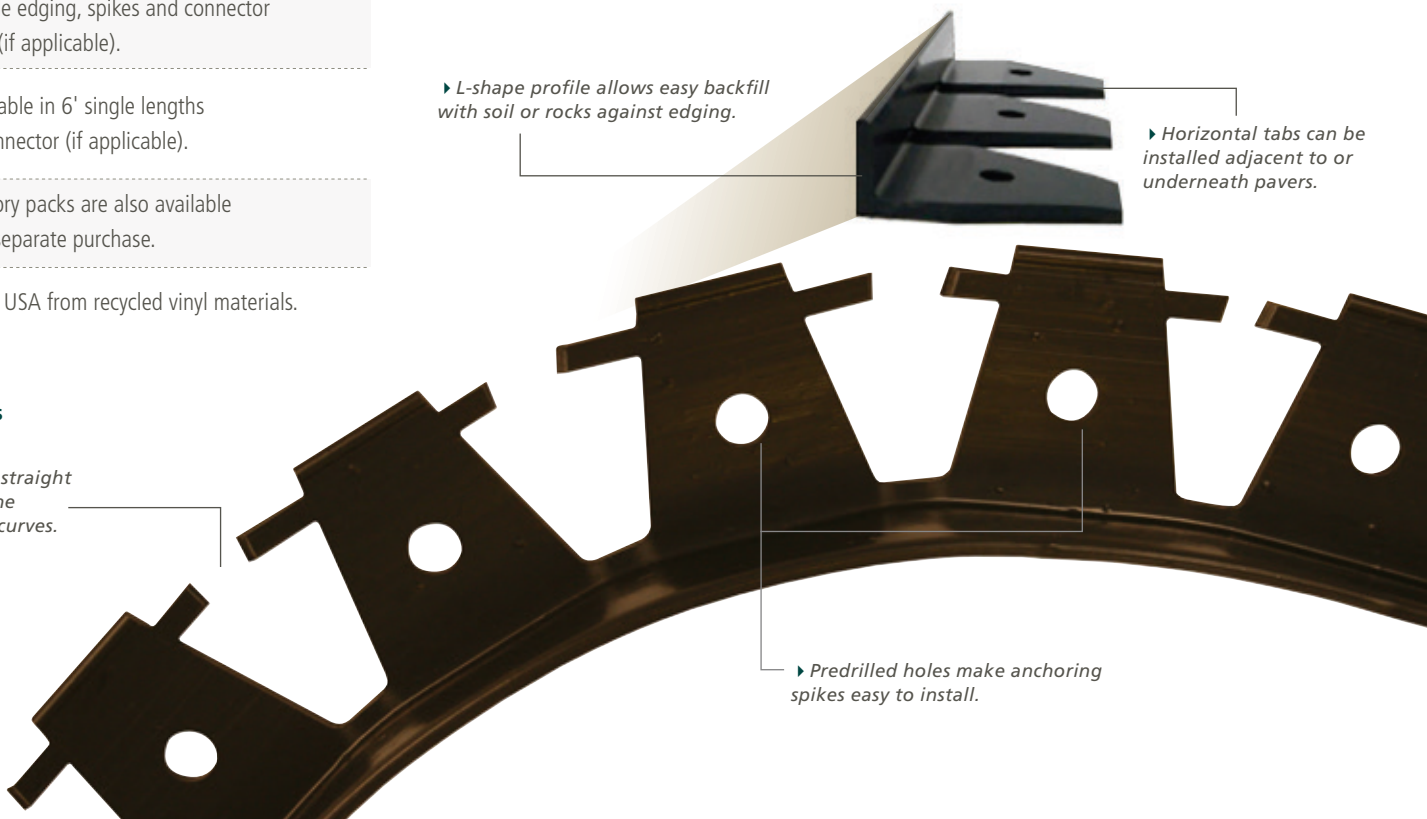

# Tree Care products

Protect and stabilize your trees with our durable, yet eco-friendly trunk protectors and locking ties.

MAINTAIN THE HEALTH OF YOUR PLANTS AND TREES



## TREE TRUNK PROTECTORS

Tree trunk protectors are designed to shield tree trunks from damaging string trimmers, while also protecting against bark damage from gardening equipment, tools, rodents and other small pests. Each protector stands 9" tall and is manufactured in round tube form, which allows it to keep its shape, even in hot sun. This product is not intended for use as a deer guard.

### Product Features

- ▶ Easy to install.
- ▶ Protectors are made to match the bark color of most young trees.
- ▶ For larger trees locking tabs connect multiple protectors.

In-store sku's typically include 20 individually labeled tree trunk protectors, shipped in a cut-case displayer.

Product possesses great crossover appeal in landscape and weed trimmer/lawn mower sections of retailers.

E-commerce sku's are available in a variety of case sizes from 3-count up to 100-count.

Manufactured in the USA from recycled plastic materials.

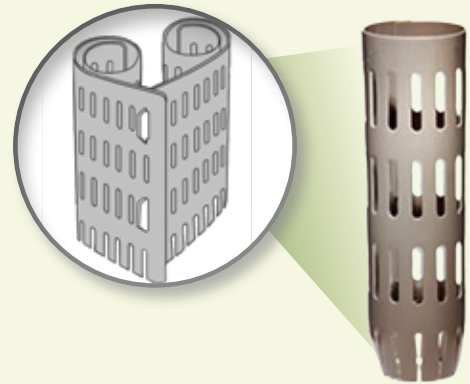

## LOCKING TREE TIES

Locking tree ties hold support stakes to smaller trees and serve a variety of other horticultural uses. The flexible chain is available in 1/2" and 1" widths and is simply pulled through itself and twisted into a locking position. Our locking ties are formulated for increased flexibility and minimizing damage to tree surface. Cuts easily with standard scissors or garden shears and has multipurpose function for other uses like bundling cords and hoses.

8' coils are available in gravity-feed displayer. Also available in 100' and 250' coils.

Manufactured in the USA from recycled plastic materials.

### Product Features

- ▶ Flexible, self-locking chain for use on plants and small trees
- ▶ Use to secure things around the house, including cables and hoses



# Marine products

05

DOCK  
EDGING

Our dock edging systems are engineered for use with commercial or private boat dock installations. Made from durable, marine-grade flexible PVC, our dock edging will not crack, rot or deteriorate. Choose from different profile options for protection of dock sides, vertical pilings and railing supports.

PROTECT YOUR DOCK AND BOAT



## MARINE DOCK EDGING

Marine dock edging protects docks and boats from damaging impact. Manufactured from durable marine-grade vinyl, it holds up to temperature extremes and is unaffected by oil, gasoline or saltwater. There are two general profile shapes available: P-shape which is intended for installation on horizontal surfaces only and D-shape which can be used both, vertical and horizontal surfaces.

Store project kits include edging and deck screws.

Boxed coils are available in 16' and 25' lengths.

Compact coiled form permits long lengths to be merchandised, handled and shipped efficiently.

Manufactured in the USA from recycled vinyl materials.

Available in white or black



## Product Features

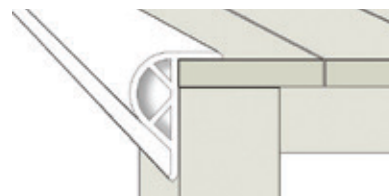

▶ P-shape design attaches to the deck top and side with included deck screws.

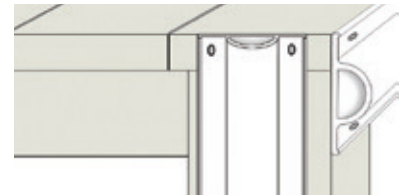

▶ Versatile D-shape design can be used on both, vertical and horizontal surfaces.



### 5000 SERIES

Our standard, 2-cavity P-shape design suitable for smaller, private docks.



### 5007 SERIES

Our heavy-duty, 4-cavity design in the shape of an elongated "D" to provide extended points of contact.



### 5001 SERIES

Our heavy-duty, 3-cavity design in the shape of an elongated "P" to provide extended points of contact.



### 5011 SERIES

Our standard, single-cavity D-shape design suitable for smaller, private docks.

# The Competitive **Edge**

## WORLD CLASS MANUFACTURING

Headquartered in the heart of the Midwest in Marietta, Ohio, Dimex operates a 260,000 square foot modern manufacturing facility with over 20 production lines. From custom compounding to extrusion/calendaring to finishing & packaging, Dimex products meet rigorous quality specifications. Dimex also offers enhanced distribution solutions with Eastern US (Marietta, OH) and Western US (Hayward, CA) shipping points, which allow our customers to better control shipping costs and transit times.

## TRUSTED BUSINESS PARTNER

For over two decades, Dimex has built a very successful track record in the execution of a variety of store programs, from single-location independent garden centers to intermediate two-step distributors to high volume, multi-sku store programs for mass retailers. We believe in working closely with all of our customers to control costs, optimize stocking levels and maximize sell through.

### Some of the additional benefits of doing business with Dimex are:

- ▶ TWO US SHIPPING POINTS – MARIETTA, OH (EAST) AND HAYWARD, CA (WEST)
- ▶ FULL EDI CAPABILITIES (THROUGH THIRD PARTY)
- ▶ FULL E-COMMERCE PROGRAMS TO SUPPORT AND ENHANCE OUR IN-STORE PROGRAMS IN ALL PRODUCT CATEGORIES

## DIMEX IS GLOBAL

Dimex products are shipped throughout the United States, and worldwide to Canada, the Caribbean, Japan, Australia, England, Spain, The Netherlands, South Korea, and Taiwan, to name a few.





Dimex LLC

[dimexcorp.com](http://dimexcorp.com)

# Landscape, not landfill



As a responsible manufacturer of plastic products, Dimex is sensitive to the environmental impact that petroleum-based products have on our planet. Our products contain recycled materials that are otherwise destined for landfills, helping to shrink our environmental footprint. Our commitment stretches beyond plastic materials, as the corrugated packaging used in shipping and packaging our products contains 50% recycled content or more. We're committed to exploring ways that we can continue to reduce, reuse and recycle materials used in the course of our business.

**Dimex** LLC

[dimexcorp.com](http://dimexcorp.com)

28305 State Route 7, Marietta, OH 45750

P • 800.334.3776 F • 740.374.5420